

Linear guideways

EG/QE series

3.3.9.2 EGW/QEW

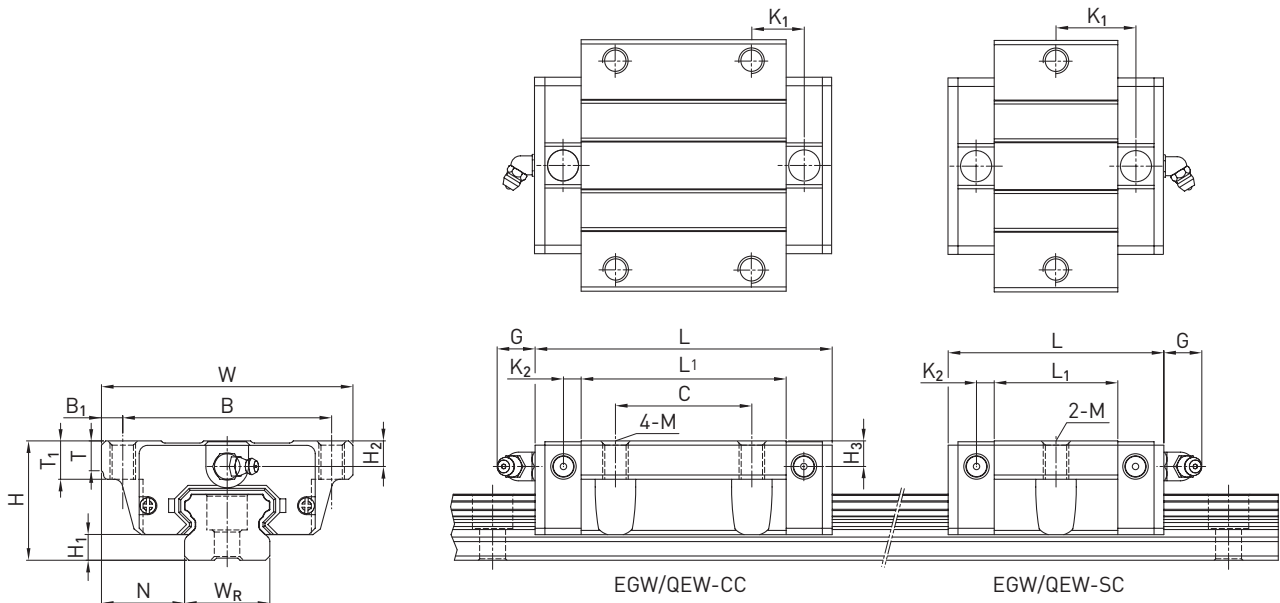

Table 3.46 Dimensions of the block

Series/size	Installation dimensions [mm]			Dimensions of the block [mm]														Load ratings [N]		Weight [kg]
	H	H ₁	N	W	B	B ₁	C	L ₁	L	K ₁	K ₂	G	M	T	T ₁	H ₂	H ₃	C _{dyn}	C ₀	
EGW15SC	24	4.5	18.5	52	41	5.5	—	23.1	40.1	14.80	3.50	5.7	M5	5.0	7	5.5	6.0	5,350	9,400	0.12
EGW15CC							26	39.8	56.8	10.15								7,830	16,190	0.21
QEW15SC	24	4.0	18.5	52	41	5.5	—	23.1	40.1	14.80	3.50	5.7	M5	5.0	—	5.5	6.0	8,560	8,790	0.12
QEW15CC							26	39.8	56.8	10.15								12,530	15,280	0.21
EGW20SC	28	6.0	19.5	59	49	5.0	—	29.0	50.0	18.75	4.15	12.0	M6	7.0	9	6.0	6.0	7,230	12,740	0.19
EGW20CC							32	48.1	69.1	12.30								10,310	21,130	0.32
QEW20SC	28	6.0	19.5	59	49	5.0	—	29.0	50.0	18.75	4.15	12.0	M6	7.0	—	6.0	6.5	11,570	12,180	0.19
QEW20CC							32	48.1	69.1	12.30								16,500	20,210	0.31
EGW25SC	33	7.0	25.0	73	60	6.5	—	35.5	59.1	21.90	4.55	12.0	M8	7.5	10	8.0	8.0	11,400	19,500	0.35
EGW25CC							35	59.0	82.6	16.15								16,270	32,400	0.59
QEW25SC	33	6.2	25.0	73	60	6.5	—	35.5	60.1	21.90	5.00	12.0	M8	7.5	—	8.0	8.0	18,240	18,900	0.34
QEW25CC							35	59.0	83.6	16.15								26,030	31,490	0.58
EGW30SC	42	10.0	31.0	90	72	9.0	—	41.5	69.5	26.75	6.00	12.0	M10	7.0	10	8.0	9.0	16,420	28,100	0.62
EGW30CC							40	70.1	98.1	21.05								23,700	47,460	1.04
QEW30SC	42	10.0	31.0	90	72	9.0	—	41.5	67.5	25.75	6.00	12.0	M10	7.0	—	8.0	9.0	26,270	27,820	0.61
QEW30CC							40	70.1	96.1	20.05								37,920	46,630	1.03
EGW35SC	48	11.0	33.0	100	82	9.0	—	45.0	75.0	28.50	7.00	12.0	M10	10.0	13	8.5	8.5	22,660	37,380	0.91
EGW35CC							50	78.0	108.0	20.00								33,350	64,840	1.40
QEW35SC	48	11.0	33.0	100	82	9.0	—	51.0	76.0	30.30	6.25	12.0	M10	10.0	13	8.5	8.5	36,390	36,430	0.77
QEW35CC							50	83.0	108.0	21.30								51,180	59,280	1.19

For dimensions of the rail, see Page 75, for standard as well as optional lubrication adapter, see Page 150.